

PCI BUS#2 DEBUGGER CONNECTORS

PULL-UP FOR IOP LOCAL BUS

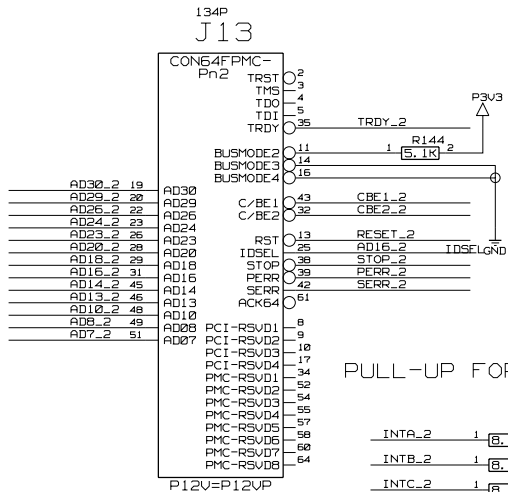

PULL-UP FOR PCI BUS#2

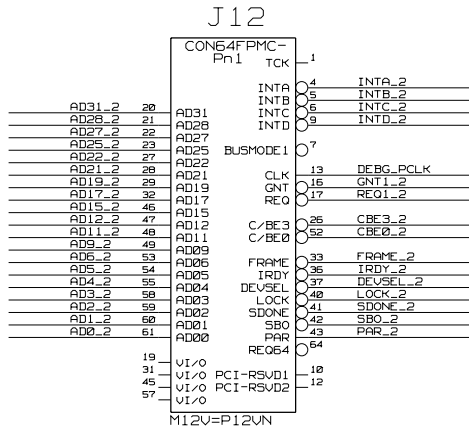
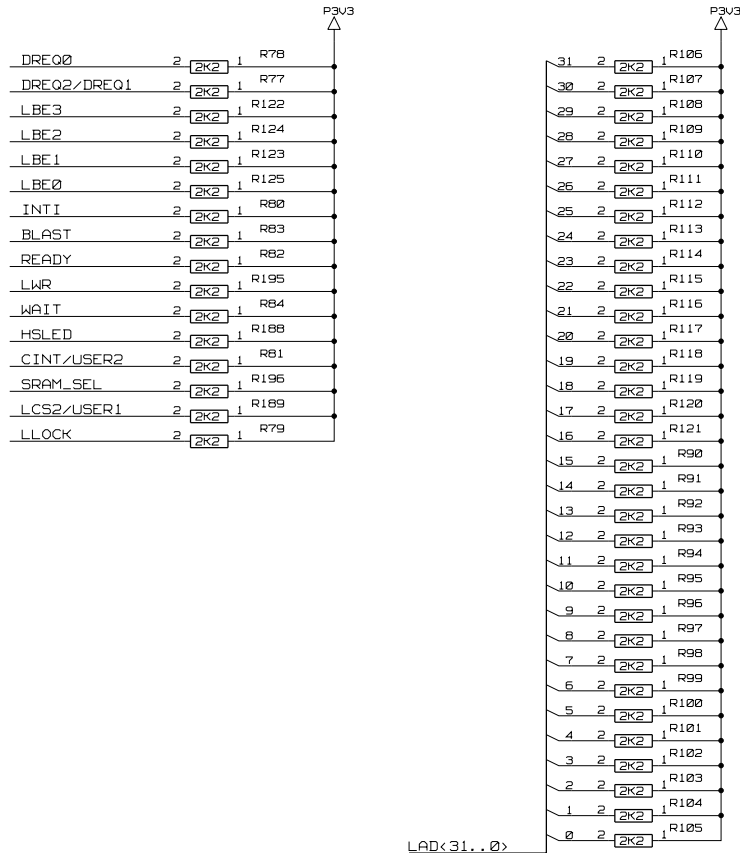
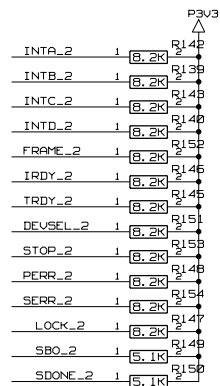

REF:	DRAWING TITLE: P3_EXT_01
 DIV. CMS DAQ GROUP EP/CMD 1211 GENEVA 23 SWITZERLAND	ABBREV: DEBUG_CON_LOCAL_PULL_UP PAGE: 2 Fo 11
	LAST_MODIFIED=Mon Jul 5 13:36:07 1999
DESIGN:	ETUDE: DATE:

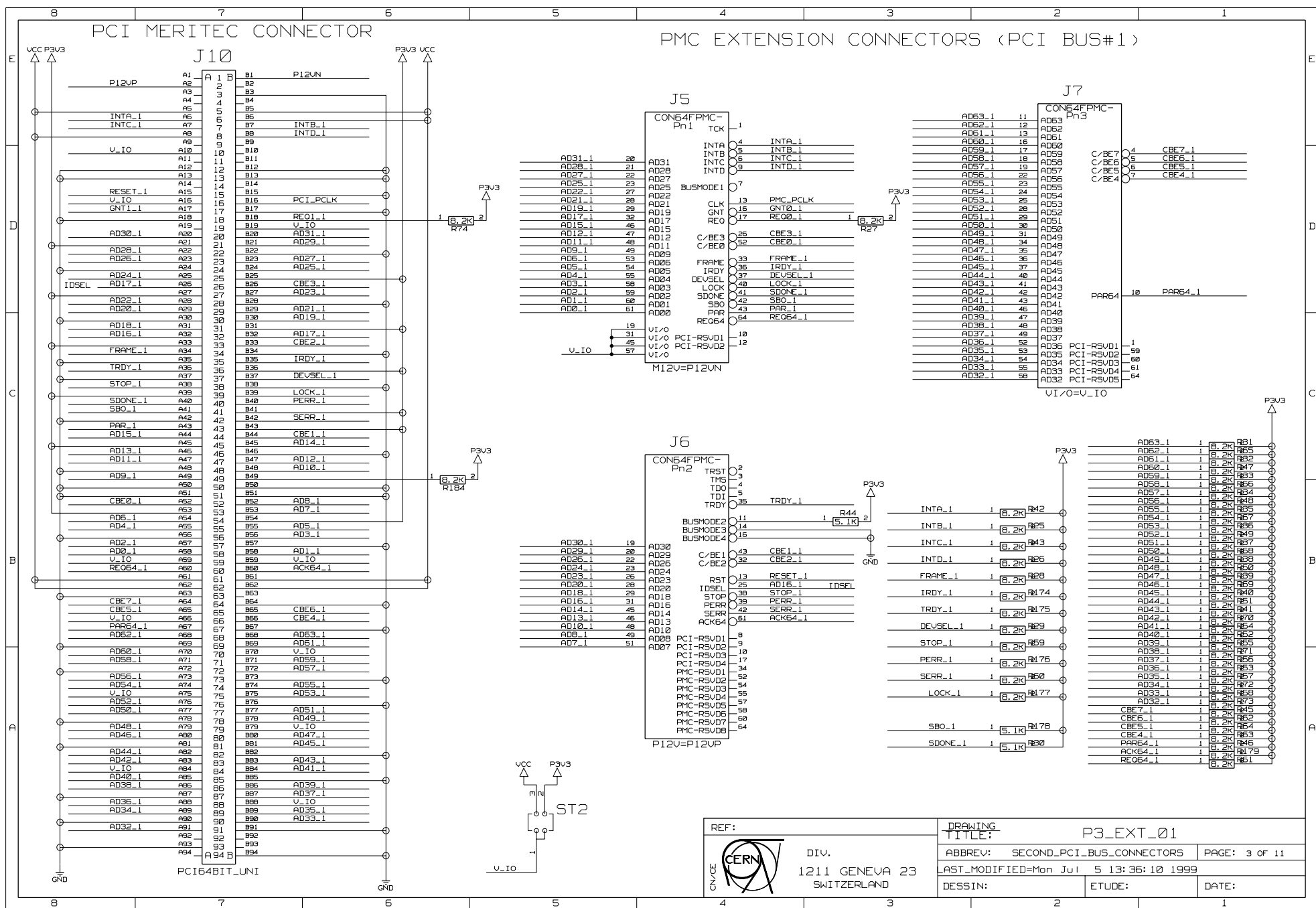

REF:	DRAWING TITLE: P3_EXT_01		
 DIV. 1211 GENEVA 23 SWITZERLAND	ABBREV: SECOND_PCI_BUS_CONNECTORS	PAGE: 3 OF 11	
	LAST_MODIFIED: Mon Jul 5 13:36:10 1999		
DESSIN:	ETUDE:	DATE:	

P3 CORE CONNECTORS (PCI BUS#1)

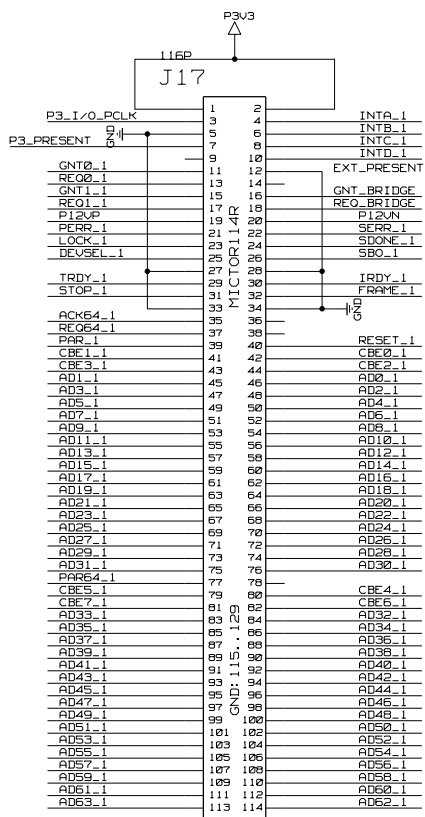

P3 OUTPUT CONNECTOR

* REQ0, GNT0, REQ1, GNT1

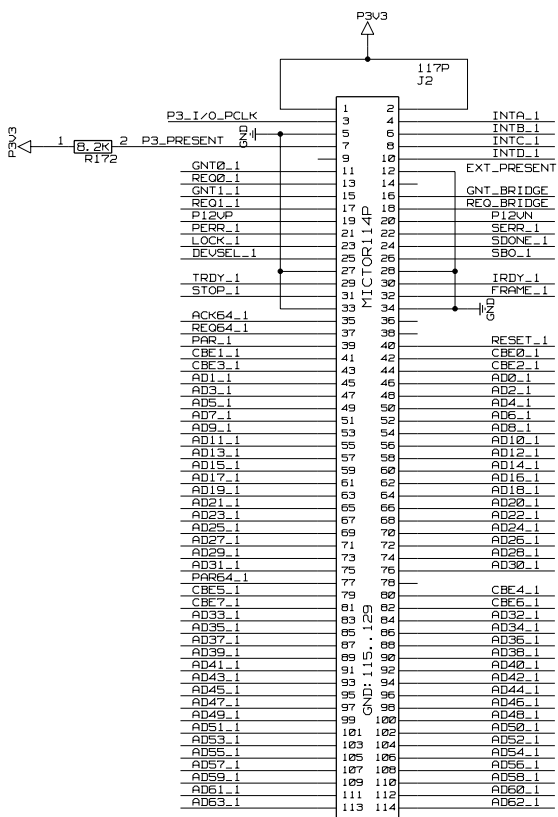

P3 INPUT CONNECTOR

REF:  CMS DAO GROUP
DIV. EP/CMO
1211 GENEVA 23
SWITZERLAND

DRAWING TITLE: P3_EXT_01	
ABBREV: CONNECTORS_TO_P3_CORE	PAGE: 4 of 11
LAST_MODIFIED=Wed Nov 10 13:36:21 1999	
DESSIN:	ETUDE:
DATE:	

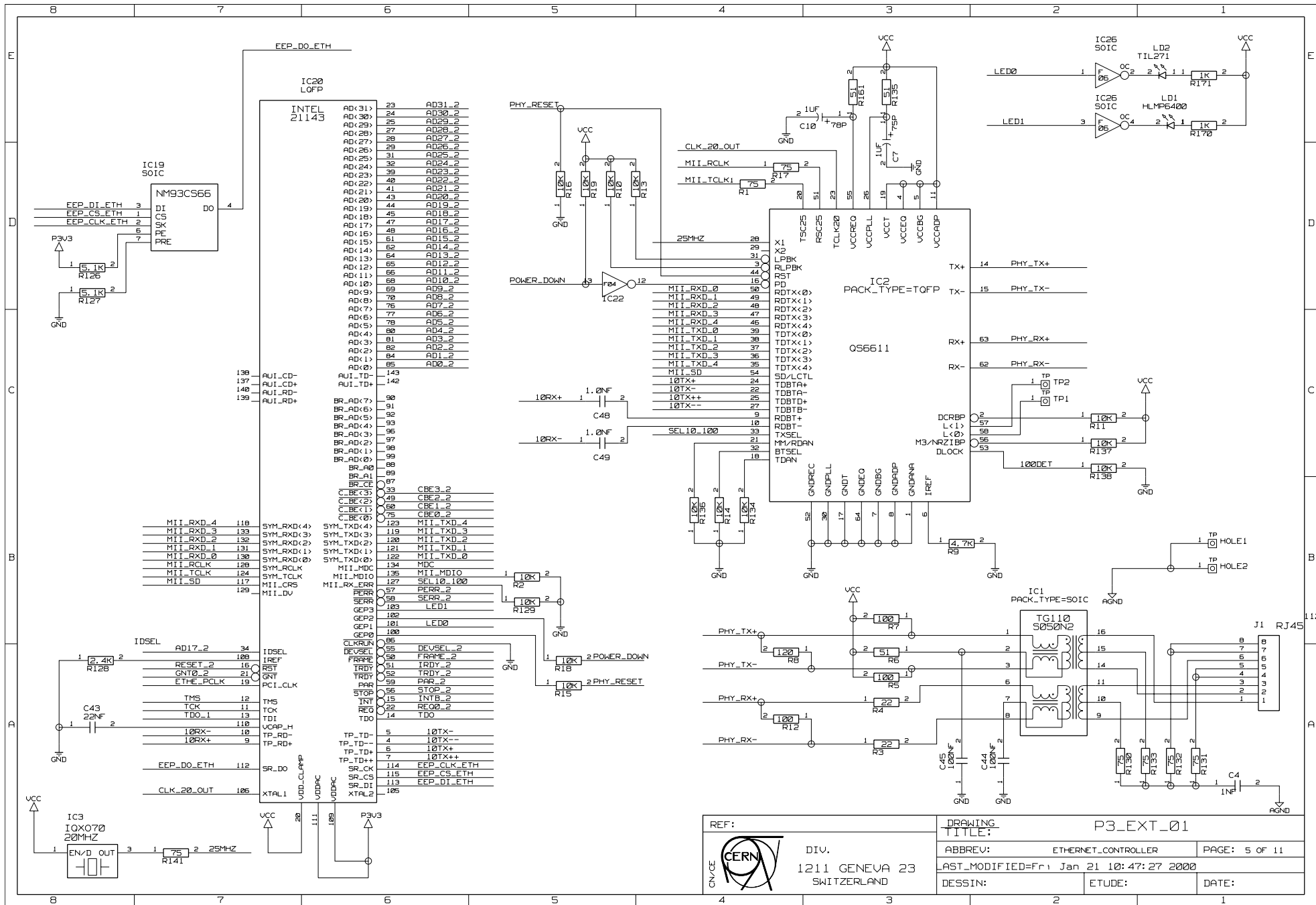

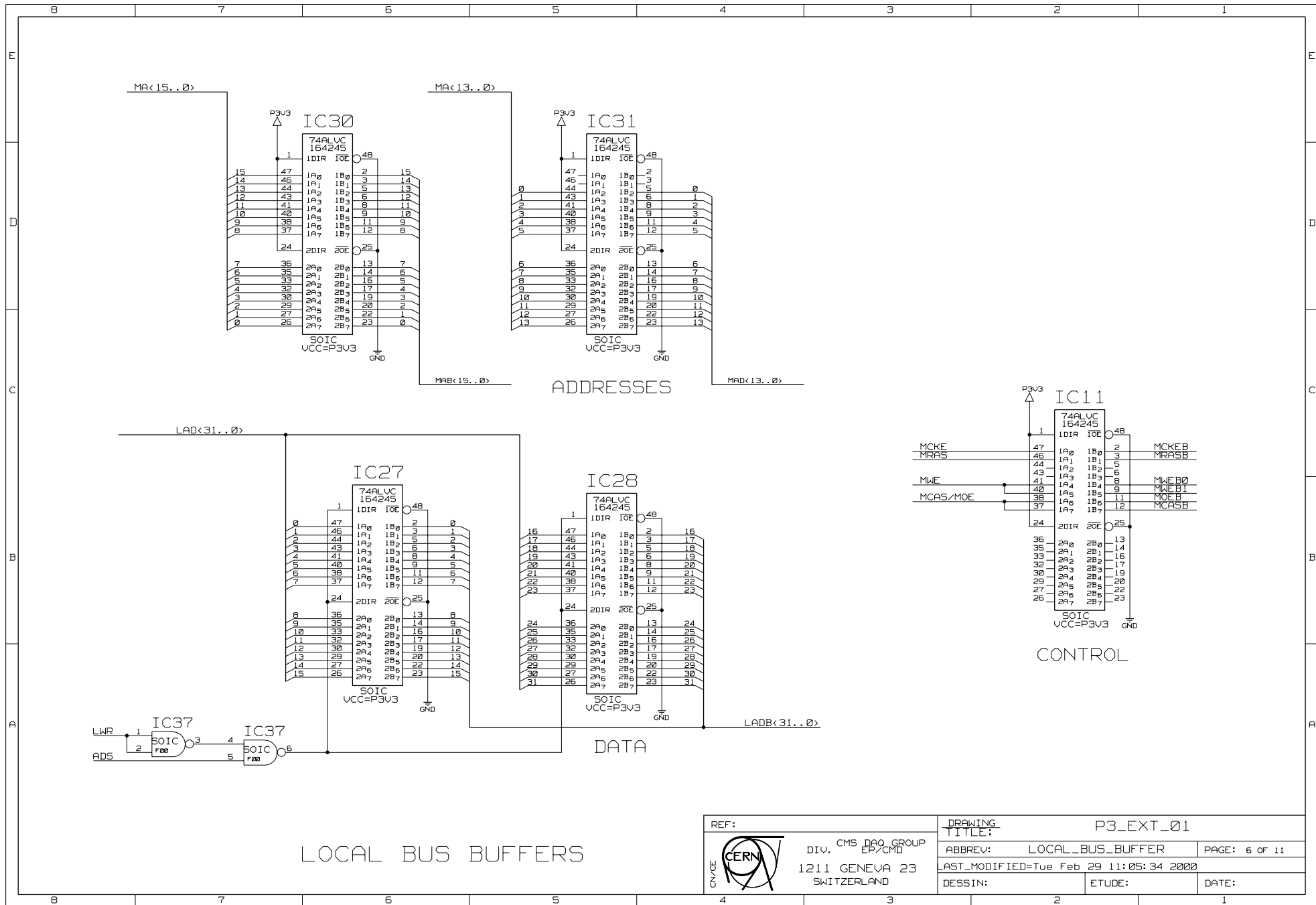

LOCAL BUS BUFFERS

REF:	DRAWING TITLE: P3_EXT_01		
 DIV. CMS DAQ GROUP EP/CMD	ABBREV: LOCAL_BUS_BUFFER	PAGE: 6 of 11	
	LAST_MODIFIED=Tue Feb 29 11:05:34 2000		
DESSIN:	ETUDE:	DATE:	

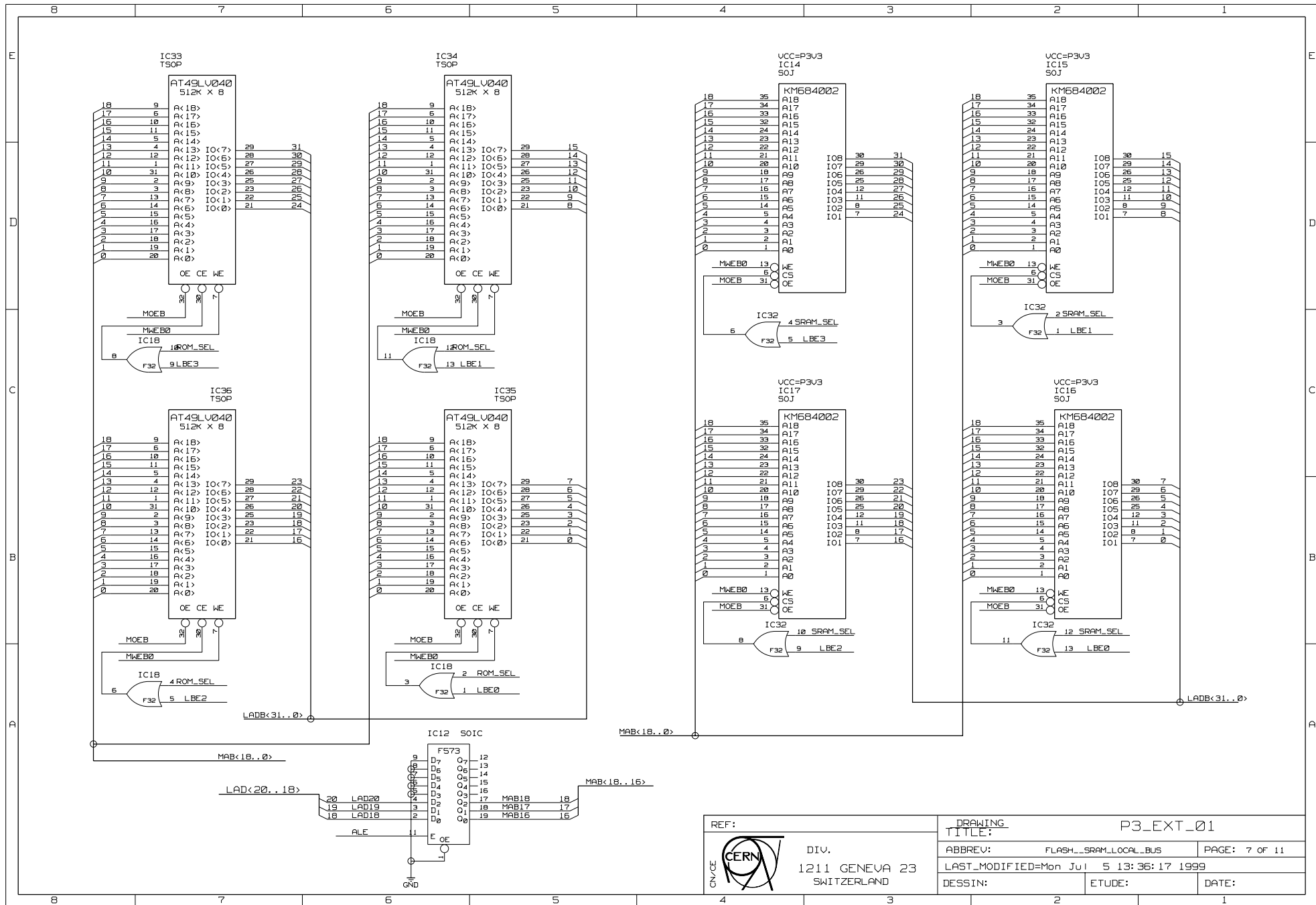

REF:	DRAWING	P3_EXT_01	
 DIV. 1211 GENEVA 23 SWITZERLAND	TITLE:	FLASH...SRAM_LOCAL_BUS	PAGE: 7 OF 11
	ABBREV:	FLASH...SRAM_LOCAL_BUS	LAST_MODIFIED: Mon Jul 5 13:36:17 1999
DESIGN:	ETUDE:	DATE:	

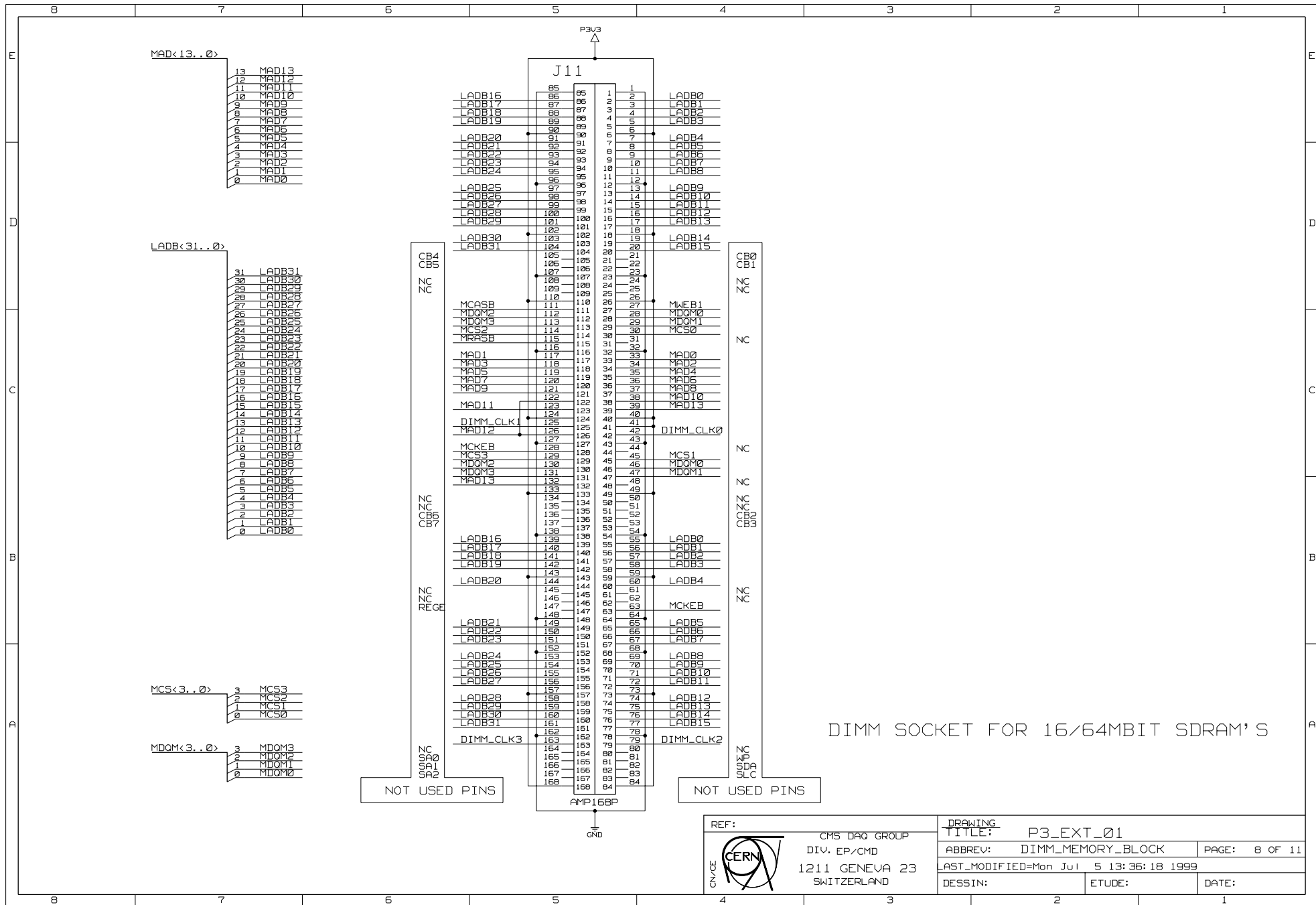

DIMM SOCKET FOR 16/64Mbit SDRAM'S

REF: 	CMS DAO GROUP		DRAWING TITLE: P3_EXT_01
	DIV. EP/CMD		ABBREV: DIMM_MEMORY_BLOCK PAGE: 8 OF 11
	1211 GENEVA 23 SWITZERLAND		LAST_MODIFIED=Mon Jul 5 13:36:18 1999
	DESSIN:	ETUDE:	DATE:

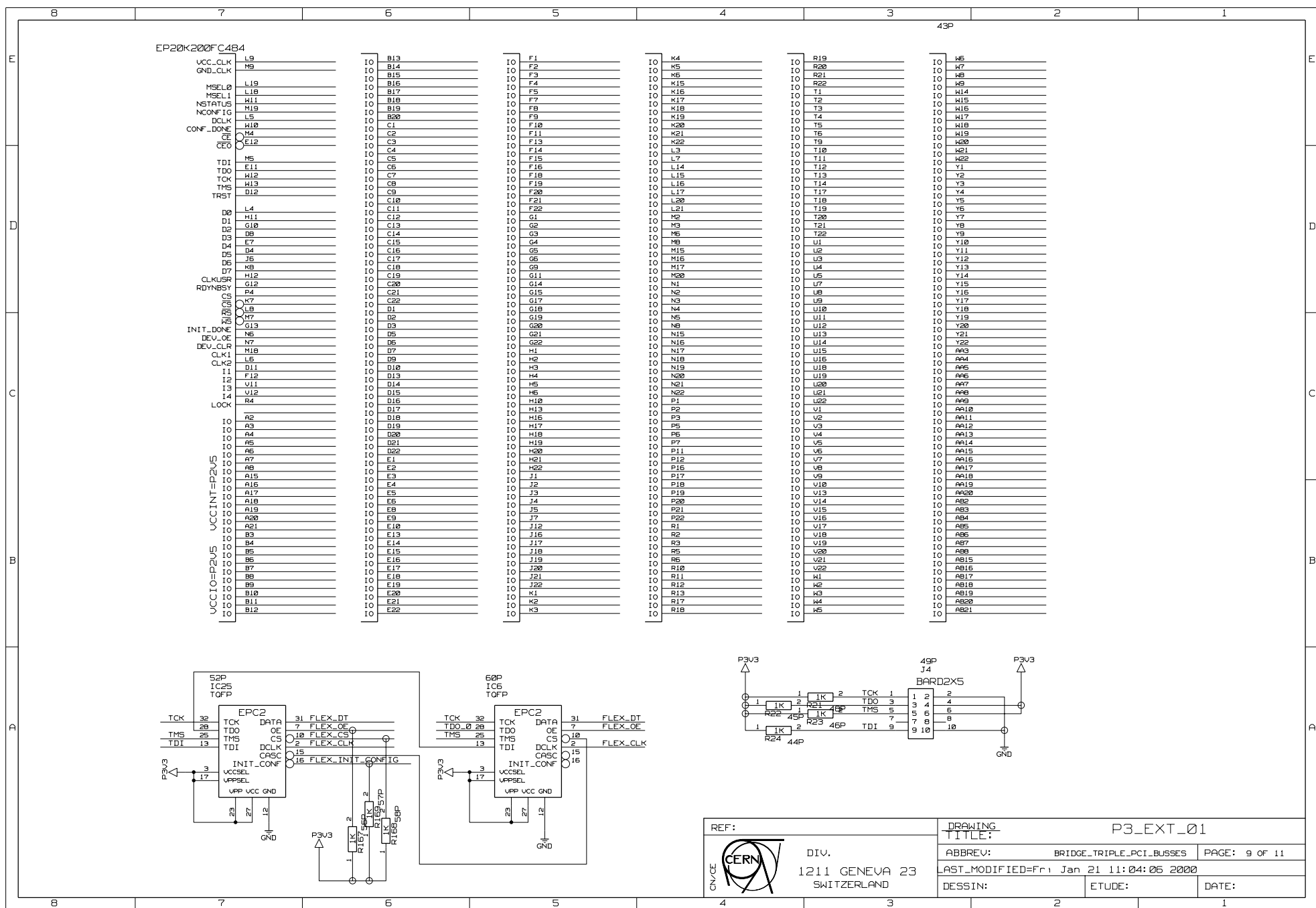

REF: DIV. 1211 GENEVA 23 SWITZERLAND

DRAWING TITLE: P3_EXT_01

ABBREV: BRIDGE_TRIPLE_PCI_BUSSES PAGE: 9 OF 11

LAST_MODIFIED=Fri Jan 21 11:04:06 2000

DESSIN: ETUDE: DATE:

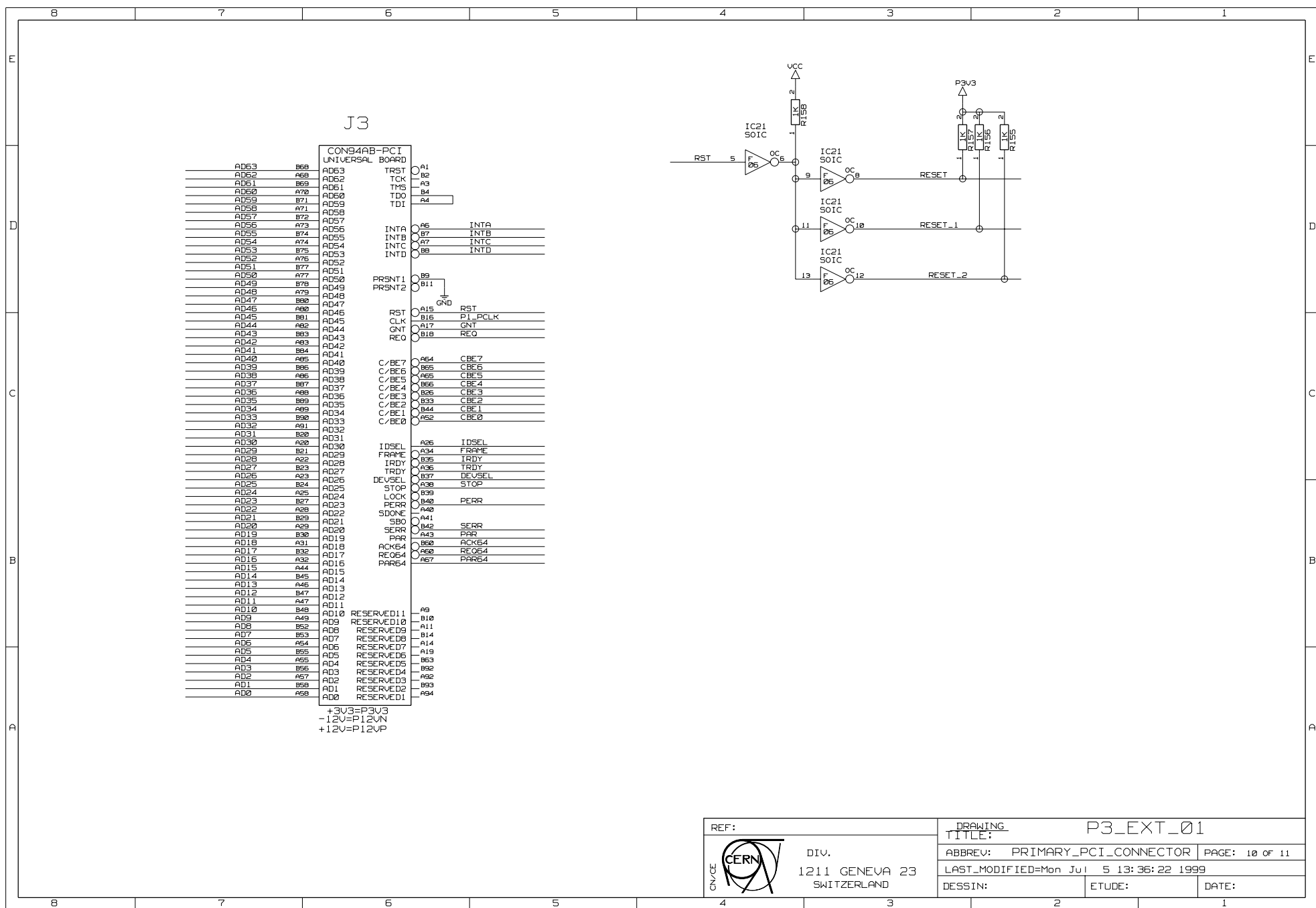

REF:	DRAWING TITLE: P3_EXT_01
 DIV. 1211 GENEVA 23 SWITZERLAND	ABBREV: PRIMARY_PCI_CONNECTOR PAGE: 10 of 11
	LAST_MODIFIED=Mon Jul 5 13:36:22 1999
	DESSIN: ETUDE: DATE:

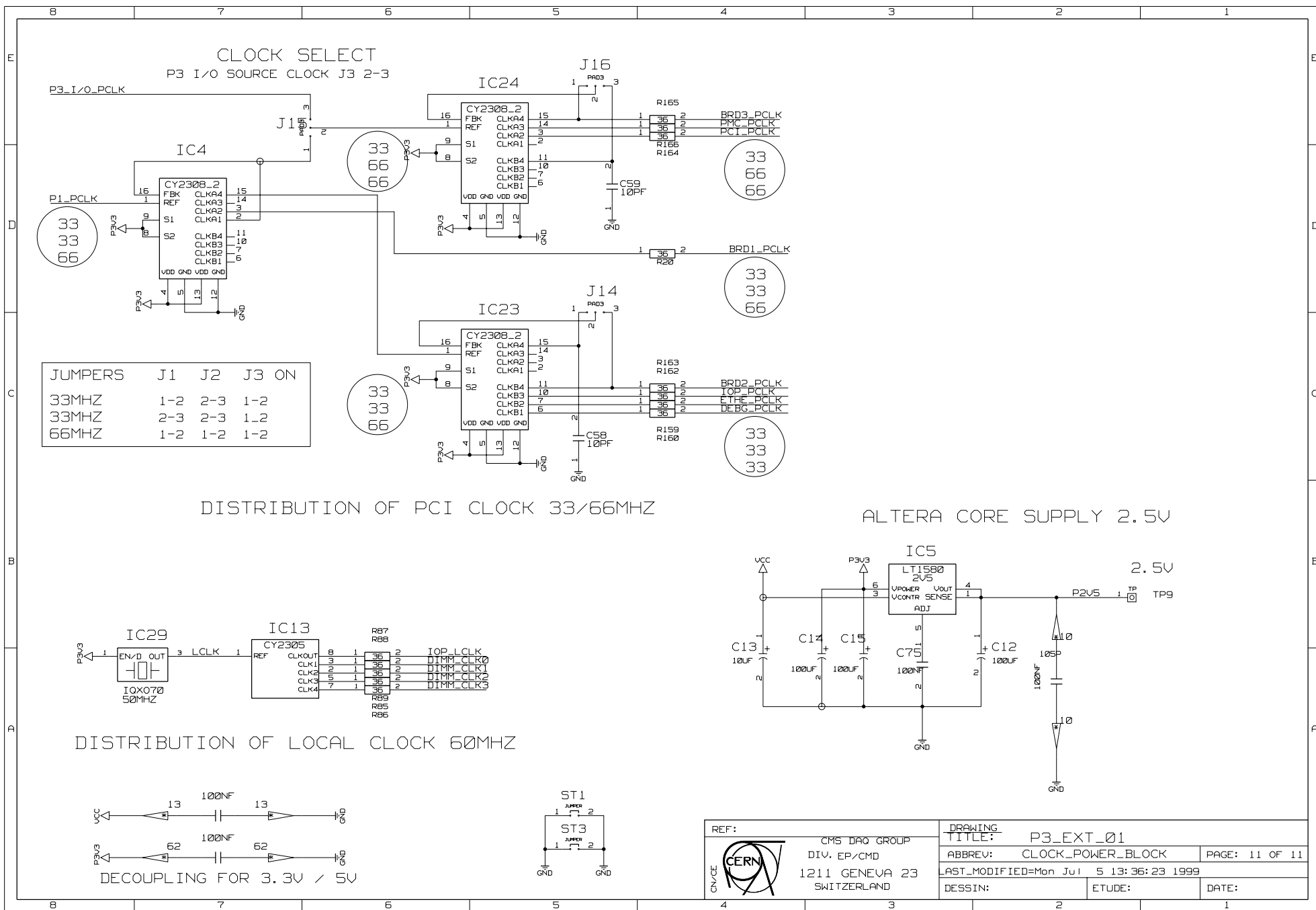

 CERN CH/VE	CMS DAO GROUP DIV. EP/CMD 1211 GENEVA 23 SWITZERLAND		DRAWING TITLE: P3_EXT_01 ABBREV: CLOCK_POWER_BLOCK PAGE: 11 OF 11 LAST_MODIFIED: Mon Jul 5 13:36:23 1999	
	DESSIN:		ETUDE:	
	DATE:		DATE:	
	DATE:		DATE:	